

AP243618P

ITEM	PART NO.	WT.
ASSEMBLY	AP243618P	282 LBS
PALLET QTY	8	2306 LBS
LID	CP2436B	139 LBS
ENCLOSURE	BP243618B	143 LBS

PART DESCRIPTION:

24" x 36" x 18"
 POLYMER CONCRETE ASSEMBLY
 STRAIGHT WALL, OPEN BOTTOM

LOAD RATING:

- TIER 15
- TIER 22

BOLT DOWN:

- HEX HEAD (STANDARD)
- PENTA HEAD

LOGO OPTIONS:

- ELECTRIC
 - COMMUNICATIONS
 - FIBER OPTICS
 - BLANK
 - WATER
 - LIGHTING
 - STREET LIGHTING
 - CAVITY (LOGO SOLD SEPARATELY)
- *OTHER OPTIONS AVAILABLE (CONTACT FACTORY)

AVAILABLE OPTIONS:

- EMS MARKER, POWER
 - EMS MARKER, TELEPHONE
 - MOUSEHOLES
 - CABLE RACKING (LOC. & QTY. REQ'D.)
 - PULLING EYES
- *OTHER OPTIONS AVAILABLE (CONTACT FACTORY)

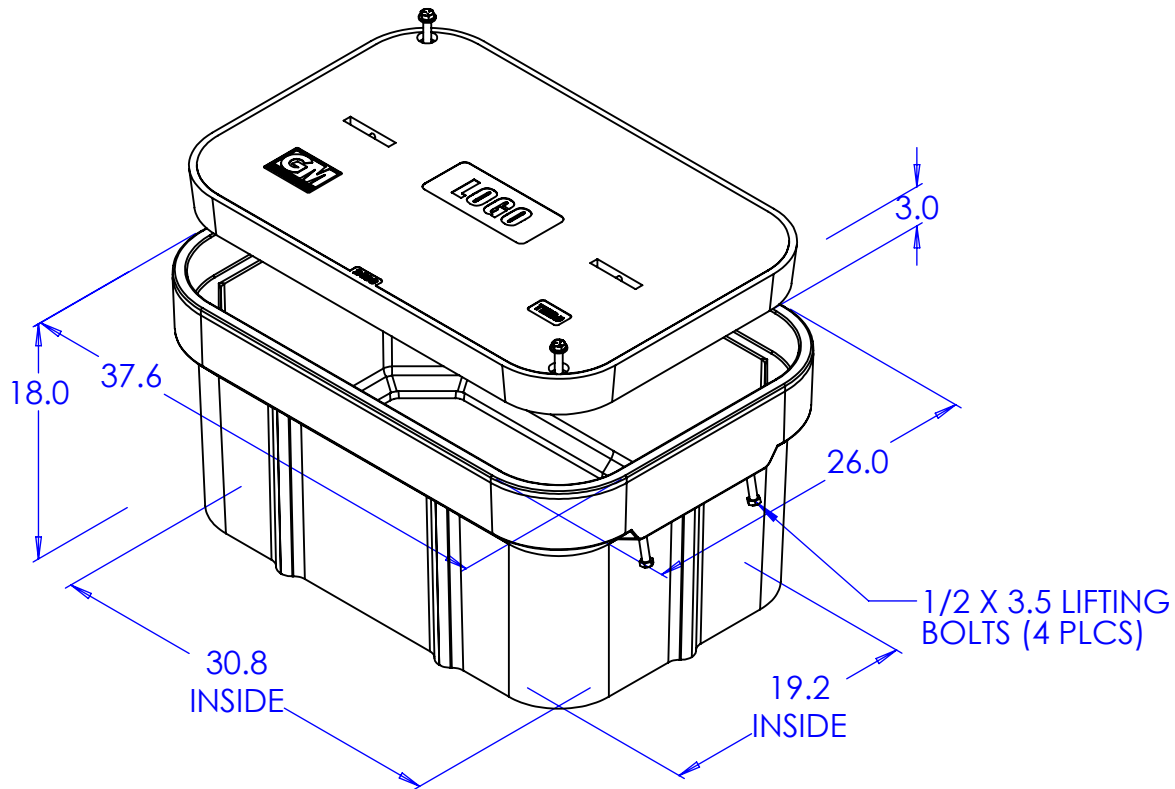
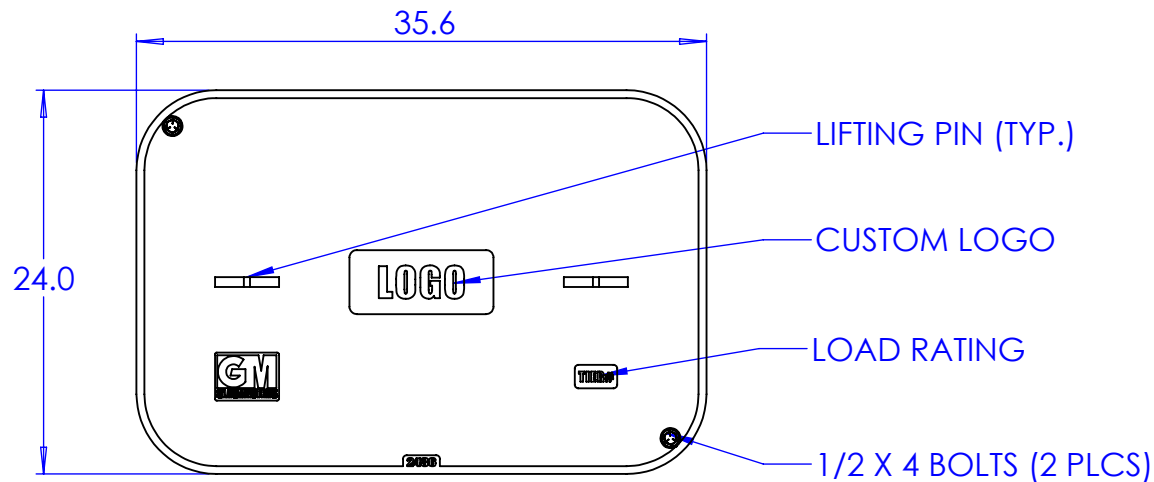

GLASMASTERS, INC.
 8873 WESTERN WAY, JAX., FL 32256
 (904) 400-7100 - (904) 358-1702 FAX
 WWW.GLASMASTERS.COM