

LID	CW3660B	176 X 2 LBS
ENCLOSURE	BV366048	439 LBS
ASSEMBLY	AV366048W	753 LBS
PALLET QTY	1	841 LBS
LOAD RATINGS TIER-15, TIER-22		

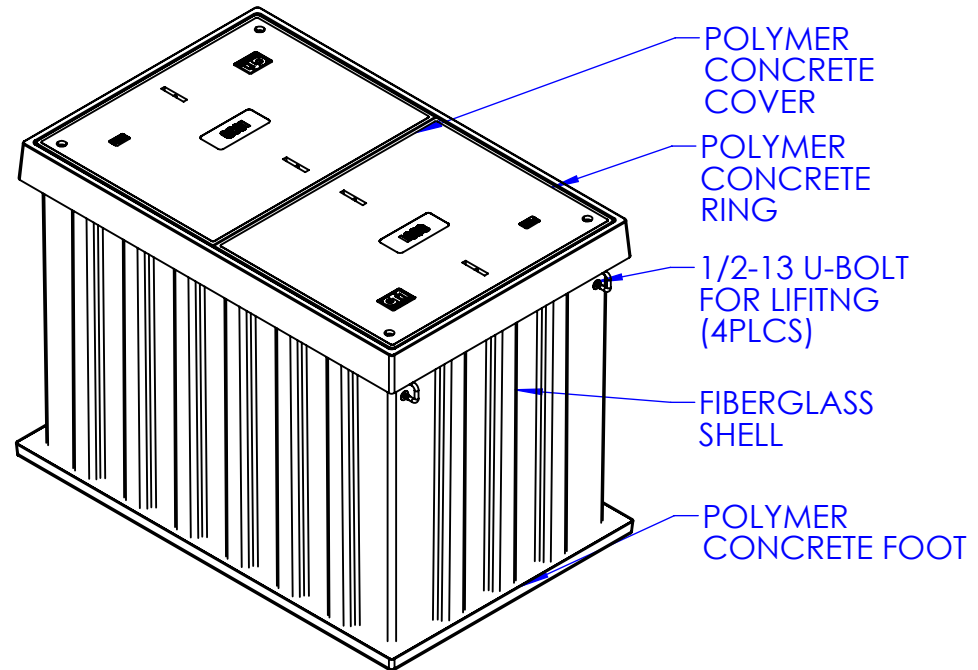
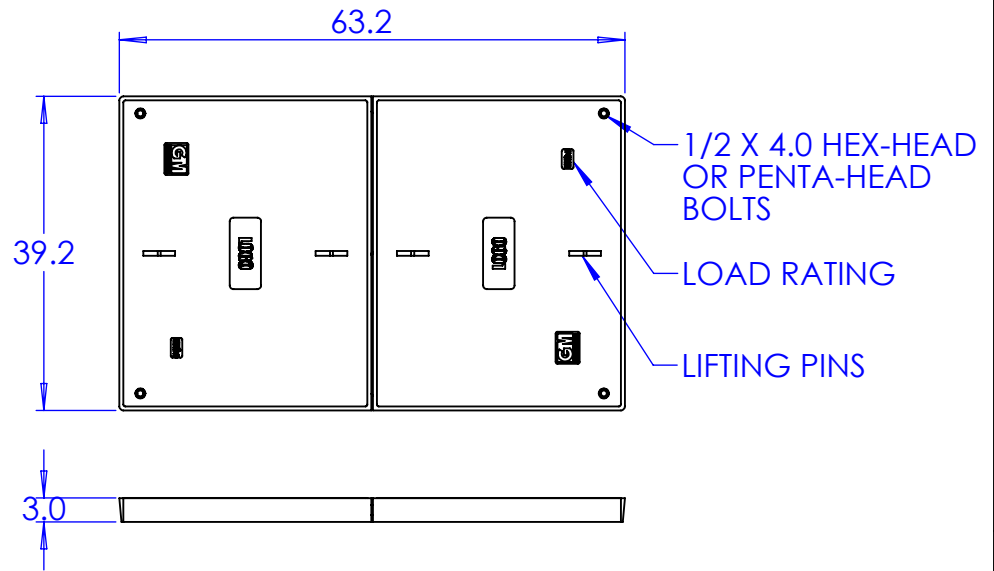
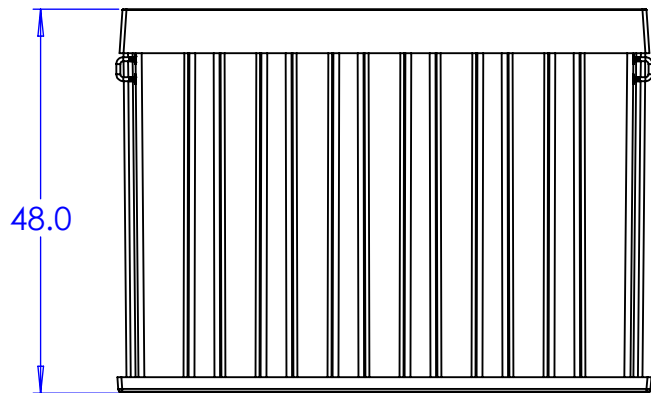
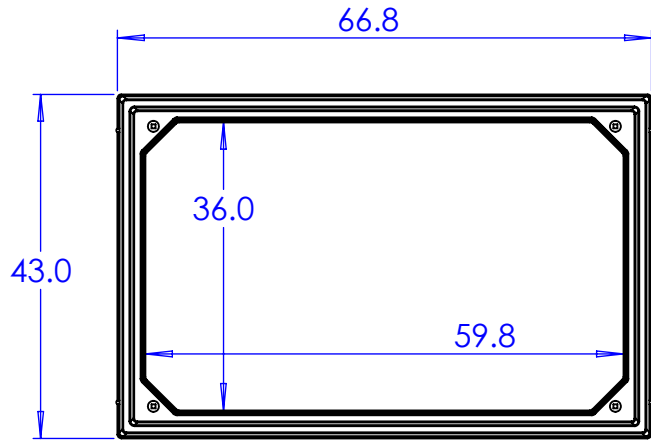

GLASMASTERS, INC.
 8873 WESTERN WAY, JAX., FL 32256
 (904) 400-7100 - (904) 358-1702 FAX
 WWW.GLASMASTERS.COM

APPROVED
 SJA

DATE
 06/28/23

DRAWN
 BMC

REV
 N/C

TITLE
 36x60x48 CORRUGATED ASSY
 SCALE
 1:24
 DWG NO
 AV366048W

SHEET
 1
 OF 1

THIS DRAWING IS CONFIDENTIAL AND PROPRIETARY AND MAY NOT BE DISTRIBUTED OR REPRODUCED WITHOUT THE EXPRESSED WRITTEN CONSENT OF GLASMASTERS, INC. ALL COPYRIGHT AND PATENT RIGHTS RESERVED. VIOLATORS WILL BE PROSECUTED.

