

# AP304824M

ITEM	PART NO.	WT.
ASSEMBLY	AP304824M	441 LBS
PALLET QTY	3	1397 LBS
LID	CM3048B	100 X 2 LBS
ENCLOSURE	BP304824B	240 LBS

**PART DESCRIPTION:**

30" x 48" x 24"  
 POLYMER CONCRETE ASSEMBLY  
 STRAIGHT WALL, OPEN BOTTOM

**LOAD RATING:**

- TIER 15
- TIER 22

**BOLT DOWN:**

- HEX HEAD (STANDARD)
- PENTA HEAD

**LOGO OPTIONS:**

- ELECTRIC
  - COMMUNICATIONS
  - FIBER OPTICS
  - BLANK
  - WATER
  - LIGHTING
  - STREET LIGHTING
  - CAVITY (LOGO SOLD SEPARATELY)
- \*OTHER OPTIONS AVAILABLE (CONTACT FACTORY)

**AVAILABLE OPTIONS:**

- EMS MARKER, POWER
  - EMS MARKER, TELEPHONE
  - MOUSEHOLES
  - CABLE RACKING (LOC. & QTY. REQ'D.)
  - PULLING EYES
- \*OTHER OPTIONS AVAILABLE (CONTACT FACTORY)

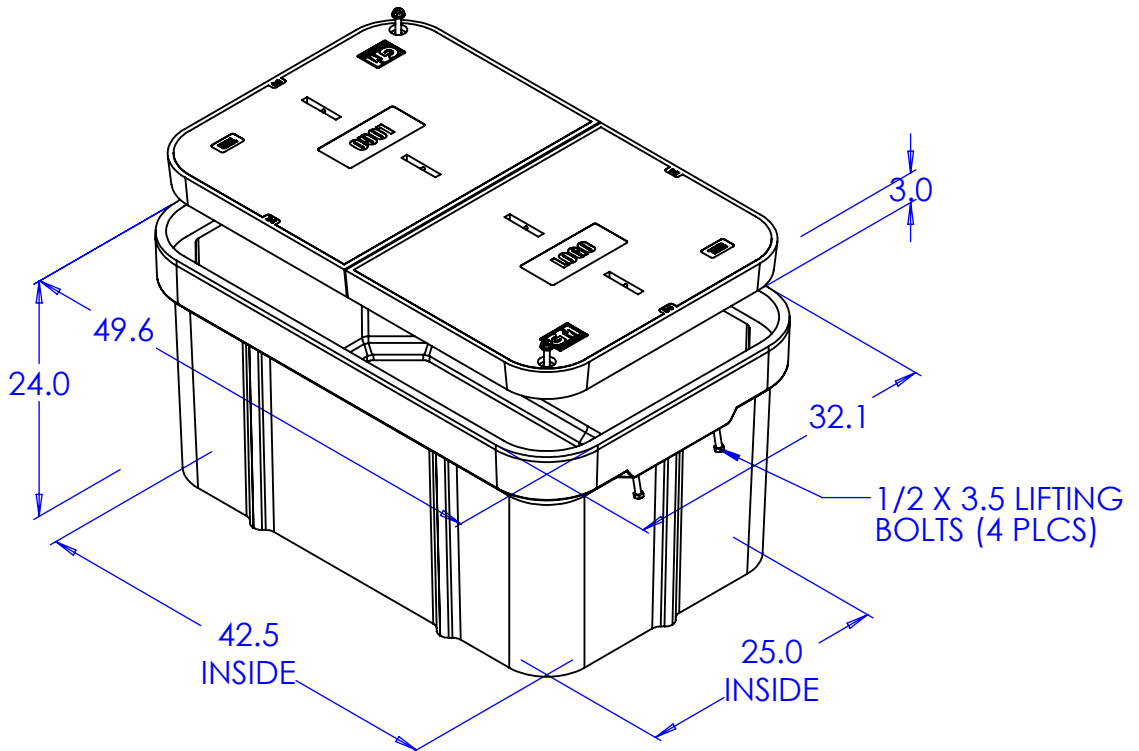
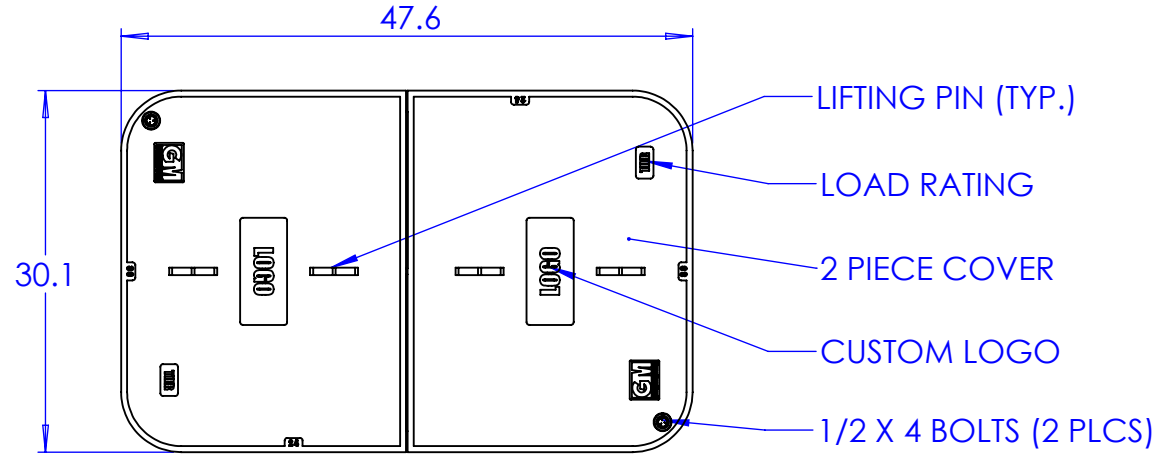

GLASMASTERS, INC.  
 8873 WESTERN WAY, JAX., FL 32256  
 (904) 400-7100 - (904) 358-1702 FAX  
 WWW.GLASMASTERS.COM