

# AP111818P

ITEM	PART NO.	WT.
ASSEMBLY	AP111818P	89 LBS
PALLET QTY	28	2559 LBS
LID	CP1118B	25 LBS
ENCLOSURE	BP111818B	64 LBS

**PART DESCRIPTION:**

11" x 18" x 18"  
 POLYMER CONCRETE ASSEMBLY  
 STRAIGHT WALL, OPEN BOTTOM

**LOAD RATING:**

- TIER 15
- TIER 22

**BOLT DOWN:**

- HEX HEAD (STANDARD)
- PENTA HEAD

**LOGO OPTIONS:**

- ELECTRIC
- COMMUNICATIONS
- FIBER OPTICS
- BLANK
- WATER
- LIGHTING
- STREET LIGHTING
- CAVITY (LOGO SOLD SEPARATELY)

\*OTHER OPTIONS AVAILABLE (CONTACT FACTORY)

**AVAILABLE OPTIONS:**

- EMS MARKER, POWER
- EMS MARKER, TELEPHONE
- MOUSEHOLES
- CABLE RACKING (LOC. & QTY. REQ'D.)
- PULLING EYES

\*OTHER OPTIONS AVAILABLE (CONTACT FACTORY)

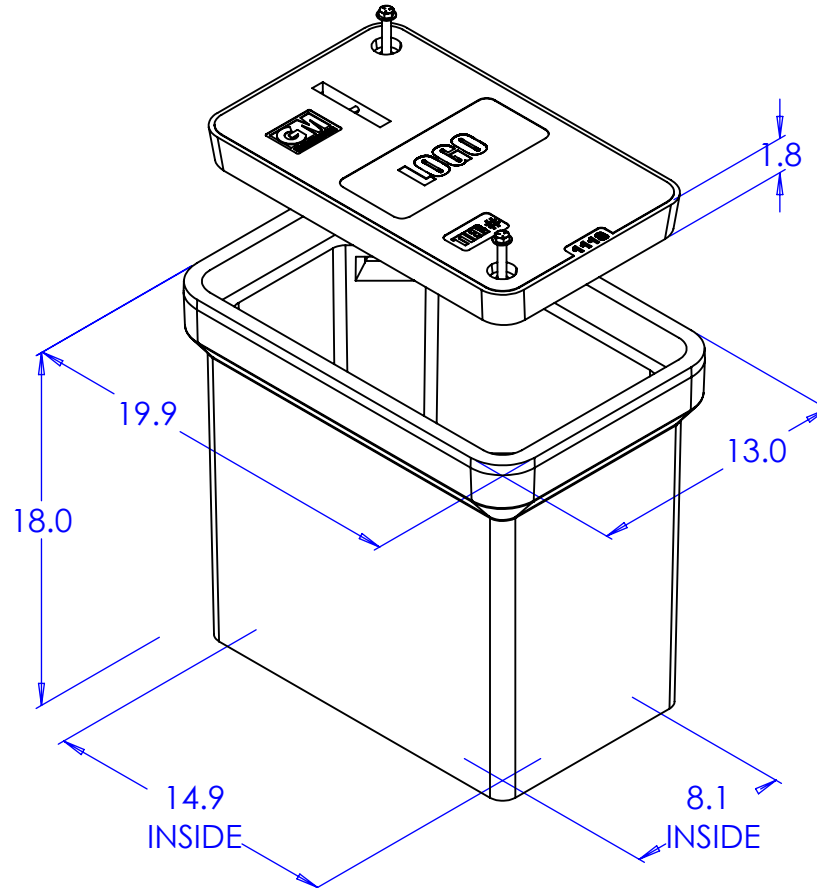
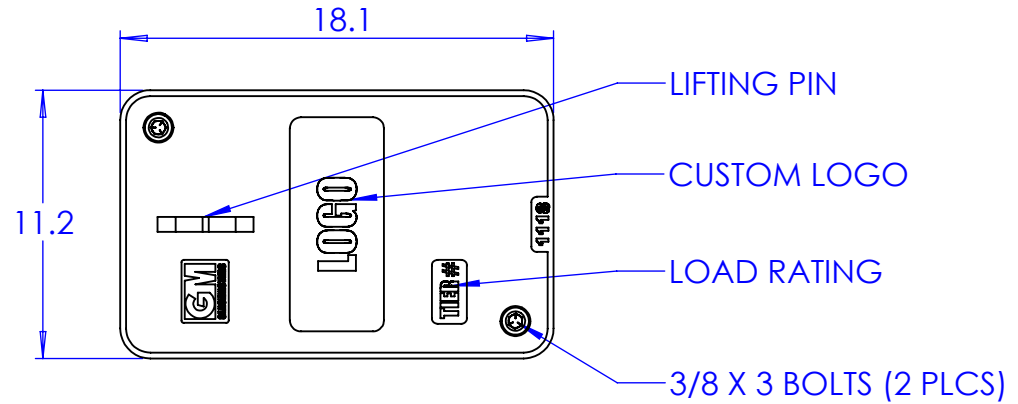

GLASMASTERS, INC.  
 8873 WESTERN WAY, JAX., FL 32256  
 (904) 400-7100 - (904) 358-1702 FAX  
 WWW.GLASMASTERS.COM