

AF243618P

ITEM	PART NO.	WT.
ASSEMBLY	AF243618P	254 LBS
PALLET QTY	6	1573 LBS
LID	CP2436B	130 LBS
ENCLOSURE	BF243618B	124 LBS

PART DESCRIPTION:
 24" x 36" x 18"
 FIBERGLASS BOX ASSEMBLY, FLARED
 WALL, OPEN BOTTOM

LOAD RATING:
 TIER 08
 TIER 15

BOLT DOWN:
 HEX HEAD (STANDARD)
 PENTA HEAD

LOGO OPTIONS:
 ELECTRIC
 COMMUNICATIONS
 FIBER OPTICS
 BLANK
 WATER
 LIGHTING
 STREET LIGHTING
 CAVITY

*OTHER OPTIONS AVAILABLE (CONTACT FACTORY)

AVAILABLE OPTIONS:
 EMS MARKER, POWER
 EMS MARKER, TELEPHONE
 MOUSEHOLES
 *OTHER OPTIONS AVAILABLE (CONTACT FACTORY)

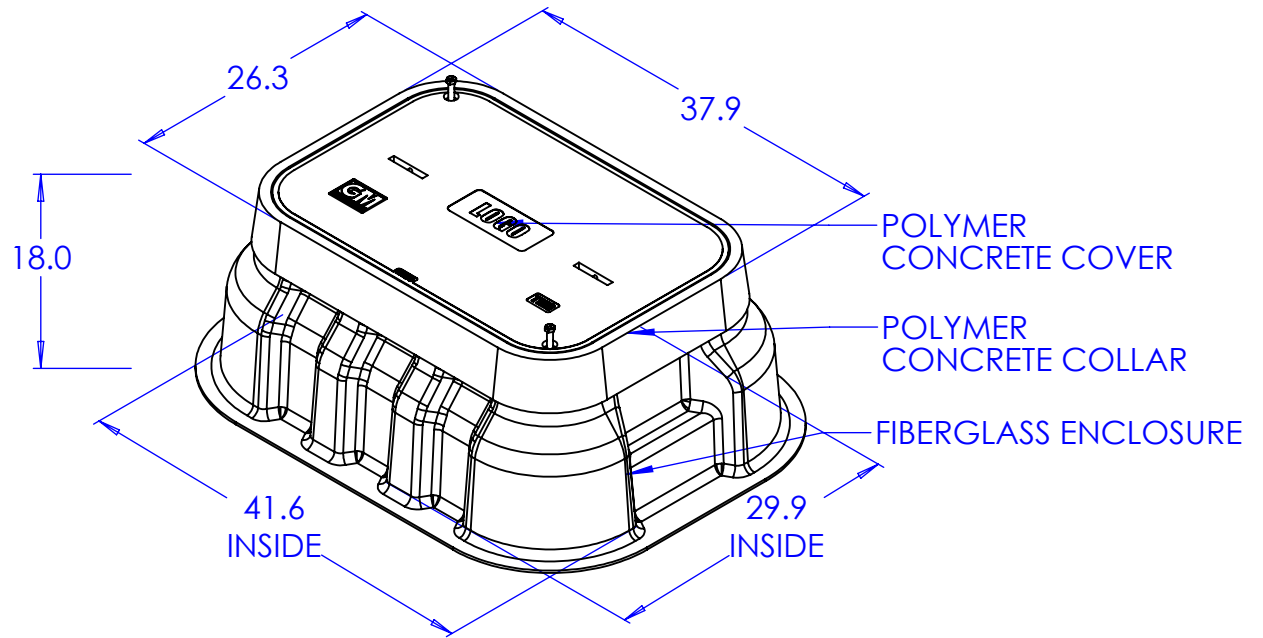
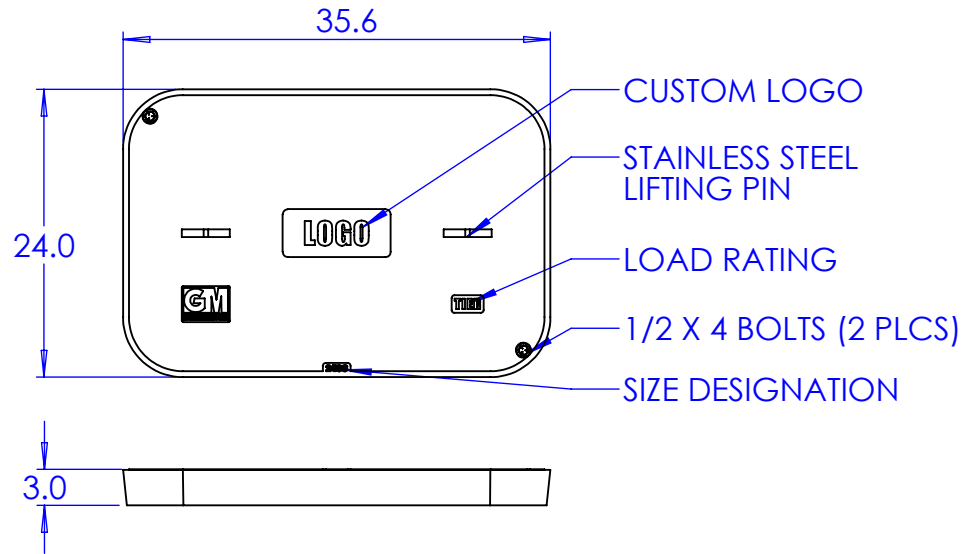

GLASMASTERS, INC.
 8873 WESTERN WAY, JAX., FL 32256
 (904) 400-7100 - (904) 358-1702 FAX
 WWW.GLASMASTERS.COM