

AF111812P

ITEM	PART NO.	WT.
ASSEMBLY	AF111812P	55 LBS
PALLET QTY	40	2246 LBS
LID	CP1118B	26 LBS
ENCLOSURE	BF111812B	29 LBS

PART DESCRIPTION:
 11" x 18" x 12"
 FIBERGLASS BOX ASSEMBLY, FLARED
 WALL, OPEN BOTTOM

LOAD RATING:

- TIER 08
- TIER 15

BOLT DOWN:

- HEX HEAD (STANDARD)
- PENTA HEAD

LOGO OPTIONS:

- ELECTRIC
- COMMUNICATIONS
- FIBER OPTICS
- BLANK
- WATER
- LIGHTING
- STREET LIGHTING
- CAVITY

*OTHER OPTIONS AVAILABLE (CONTACT FACTORY)

AVAILABLE OPTIONS:

- EMS MARKER, POWER
- EMS MARKER, TELEPHONE
- MOUSEHOLES

*OTHER OPTIONS AVAILABLE (CONTACT FACTORY)

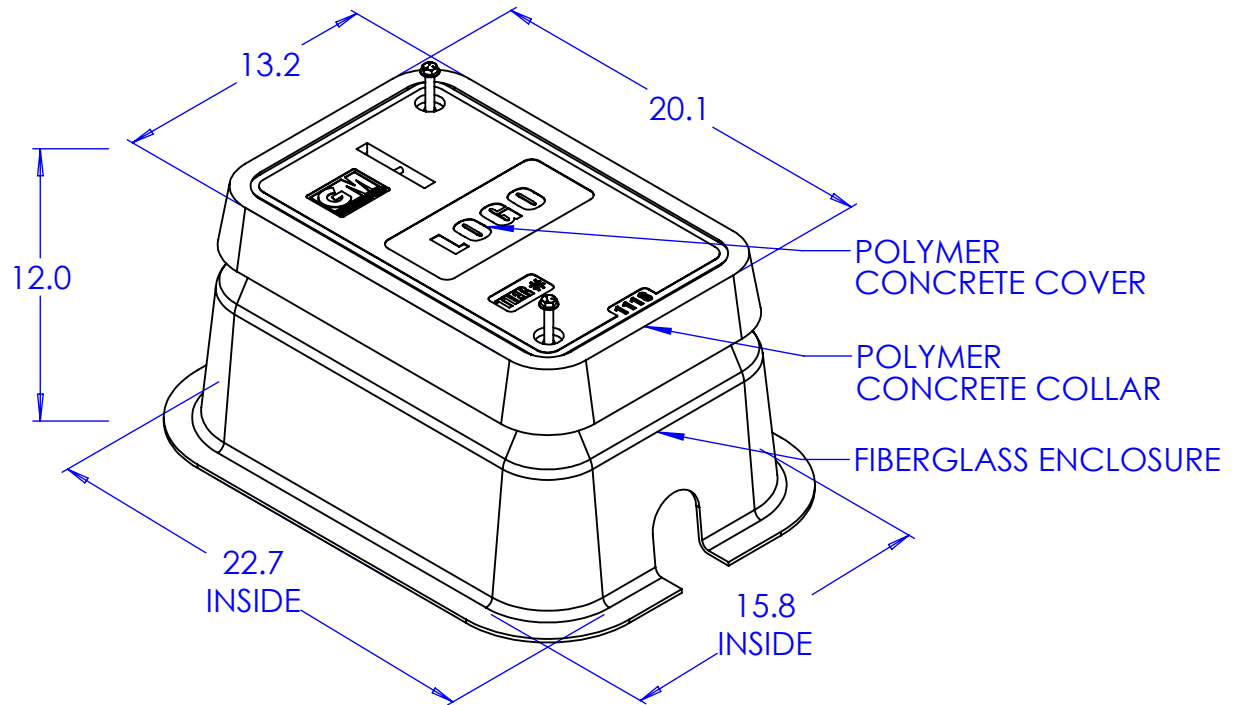
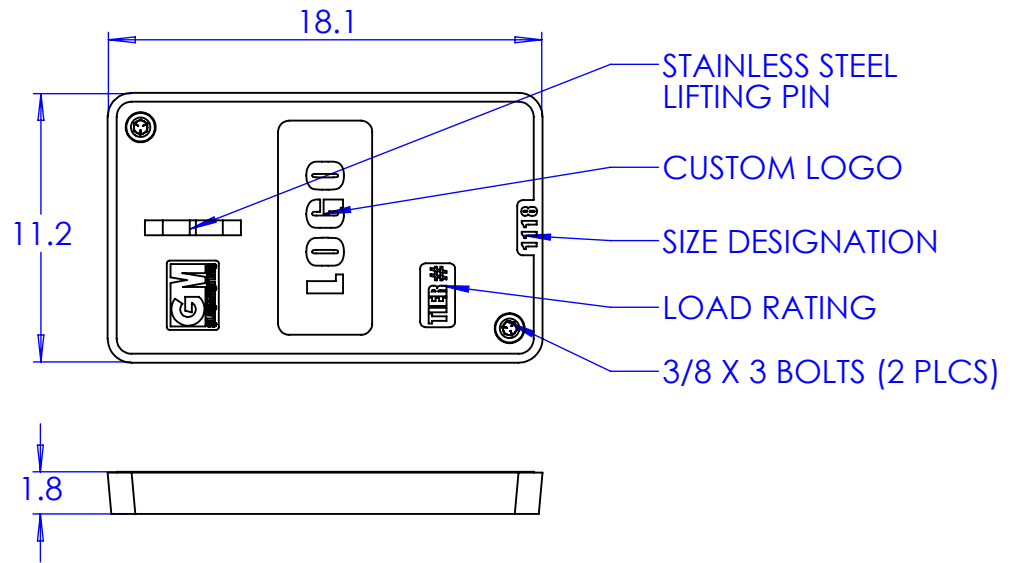

GLASMASTERS, INC.
 8873 WESTERN WAY, JAX., FL 32256
 (904) 400-7100 - (904) 358-1702 FAX
 WWW.GLASMASTERS.COM