

# AF101512P

ITEM	PART NO.	WT.
ASSEMBLY	AF101512P	46 LBS
PALLET QTY	40	1907 LBS
LID	CP1015B	20 LBS
ENCLOSURE	BF101512B	26 LBS

**PART DESCRIPTION:**  
 10" x 15" x 12"  
 FIBERGLASS BOX ASSEMBLY, FLARED  
 WALL, OPEN BOTTOM

**LOAD RATING:**  
 TIER 08  
 TIER 15

**BOLT DOWN:**  
 HEX HEAD (STANDARD)  
 PENTA HEAD

**LOGO OPTIONS:**  
 ELECTRIC  
 COMMUNICATIONS  
 FIBER OPTICS  
 BLANK  
 WATER  
 LIGHTING  
 STREET LIGHTING  
 CAVITY

\*OTHER OPTIONS AVAILABLE (CONTACT FACTORY)

**AVAILABLE OPTIONS:**  
 EMS MARKER, POWER  
 EMS MARKER, TELEPHONE  
 MOUSEHOLES  
 \*OTHER OPTIONS AVAILABLE (CONTACT FACTORY)

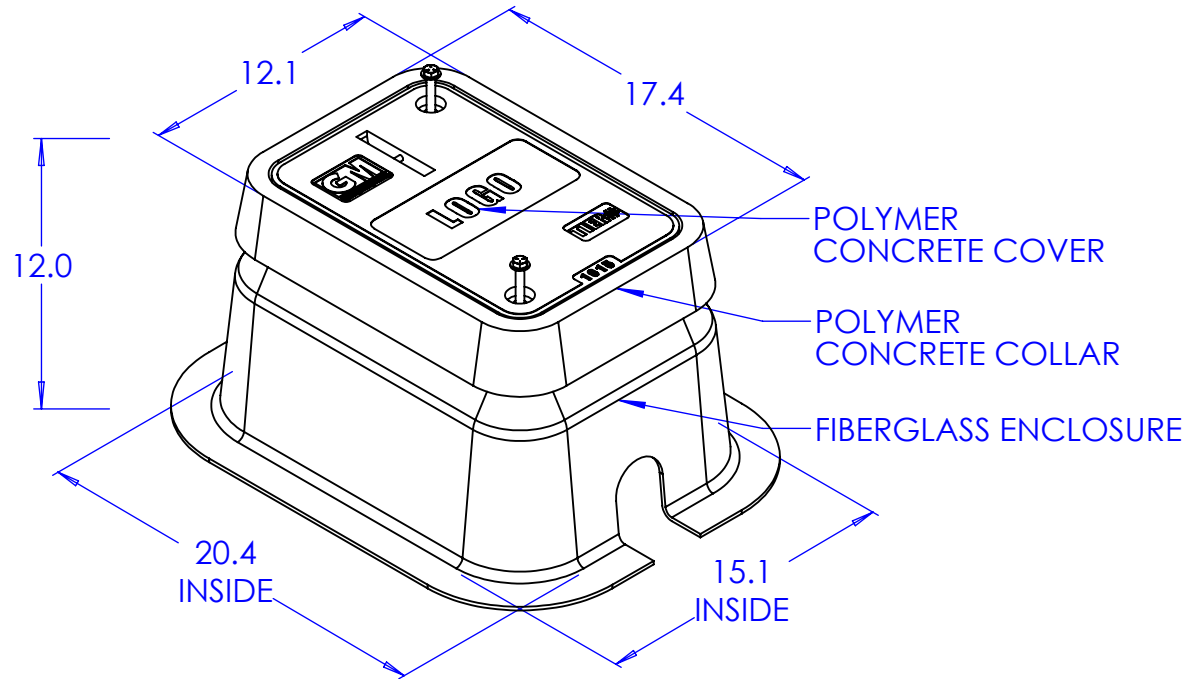
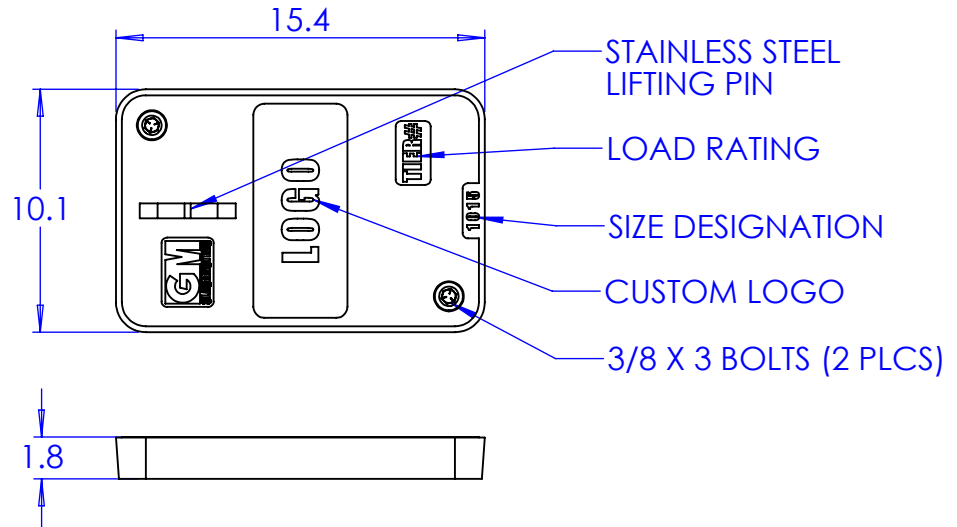

GLASMASTERS, INC.  
 8873 WESTERN WAY, JAX., FL 32256  
 (904) 400-7100 - (904) 358-1702 FAX  
 WWW.GLASMASTERS.COM